

# WELCOME TO THE WEBINAR

## “How to increase the availability of your maritime emission monitoring systems”



### Agenda

1. Regulations and Compliance
2. Optimizing existing systems
3. How to use digital services
4. SICK Maritime Service structure

# SICK at a glance

Key figures (fiscal year 2023)

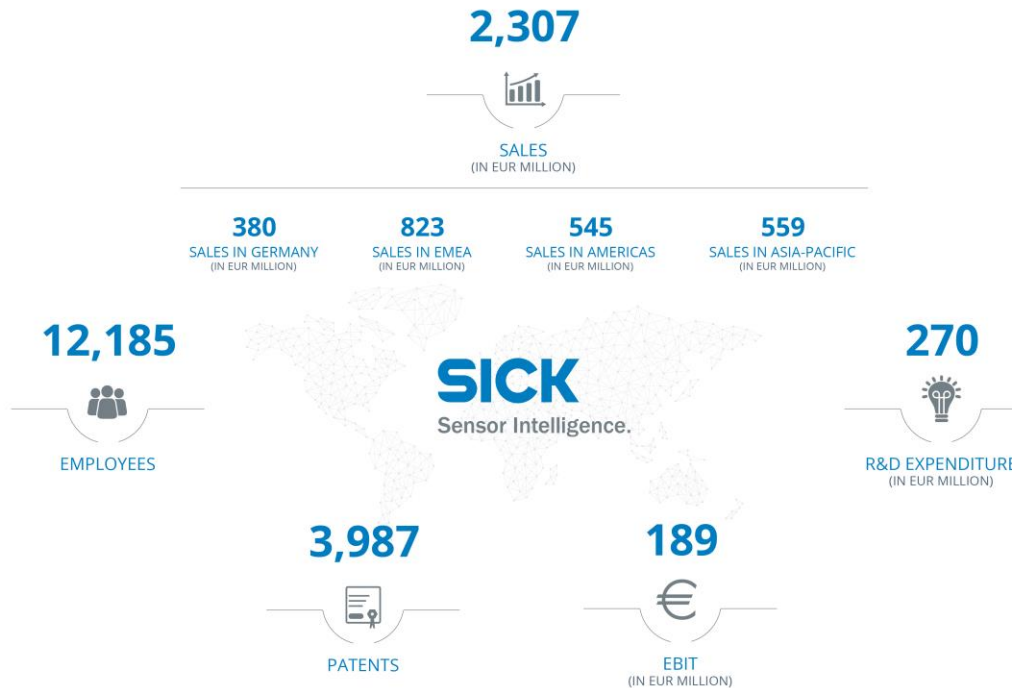

## WE ARE ONE OF THE WORLD'S LEADING COMPANIES

WE DEVELOP SENSOR SOLUTIONS FOR CUSTOMERS AROUND THE GLOBE





**SICK**  
Sensor Intelligence.

# Regulations and Compliance

# Regulations and Compliance

## Regulatory background

CEMS (continuous emission monitoring system) essential part of scrubber system

**MARPOL Annex VI**, requirements for Prevention of Air Pollution from Ships. Chapter 3:

- › Regulation 13 – Nitrogen Oxides (NOx)
- › Regulation 14 – Sulfur Oxides (SOx)...



**IMO** Vessel Operation Compliance (Mandatory)  
International: MARPOL Annex VI (Reg 13 (NOx), MARPOL Annex VI (Reg 14 (SOx))  
National: EU Directive 94/25/EC, River Rhine Regulation, other

Importance of a **well maintained** system to remain **compliant**

- › Avoid switching to more expensive fuel (e.g. MGO)
- › Lower risk of penalties / banning to berth

## Preventative Maintenance

- › **Increases availability** and reduce risk of unplanned breakdown

## Installation

- › Eliminate main **sources of errors**

## Comprehensive service approach

- › Use of **digital services** to optimize performance and availability



**Optimizing existing systems**

# Installed base data & key-learnings

First devices sold and commissioned in 2009

Experiences collected throughout the last couple of years from more than **2300 installations**

Root cause analysis → **Main error faults:**

- › Oil / water in instrument air and surrounding areas
- › High ambient temperatures
- › Improper Handling of sample gas unit / filter
- › Lack of maintenance

Impressions & solutions provided to avoid remaining faults



# Bad instrument air quality

## Oil / Water in instrument air

Leads to:

- › Contamination inside measuring cell, filtering system, electronics...
- › Downtime / wrong measuring results (I-air used as zero gas)

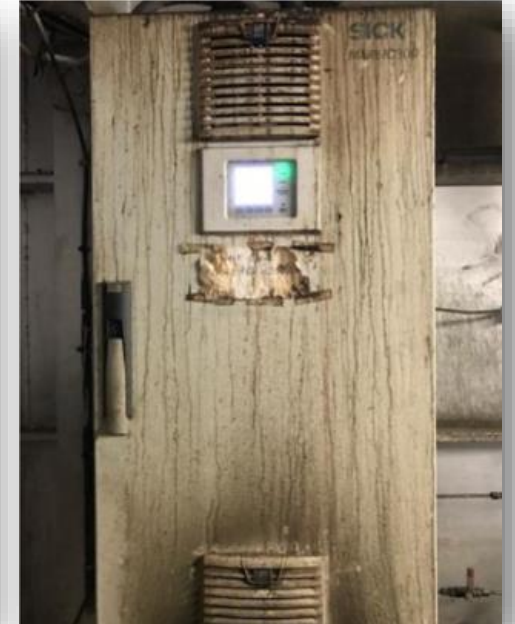
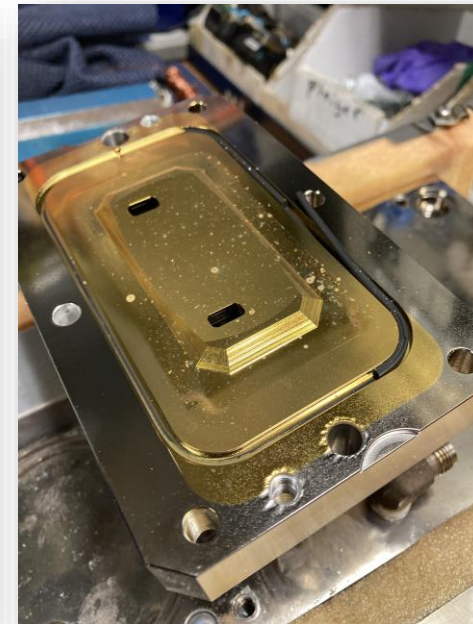

# Bad instrument air quality

## Solution:

**Step 1: Improve instrument air quality from compressed air supply**

**Step 2: Use additional prefilters to clean**

**Cyclone prefilter to dry & clean**

**Coarse filter to remove particles**

Both with floating drain

- › No additional power supply required
- › Maintenance intervall of 1 year



Install between air supply and existing filtering system to improve the performance of our preparation unit

## SICK – AIR TREATMENT MARSIC 300 – SPN 0024 (MAT NO 5342027)

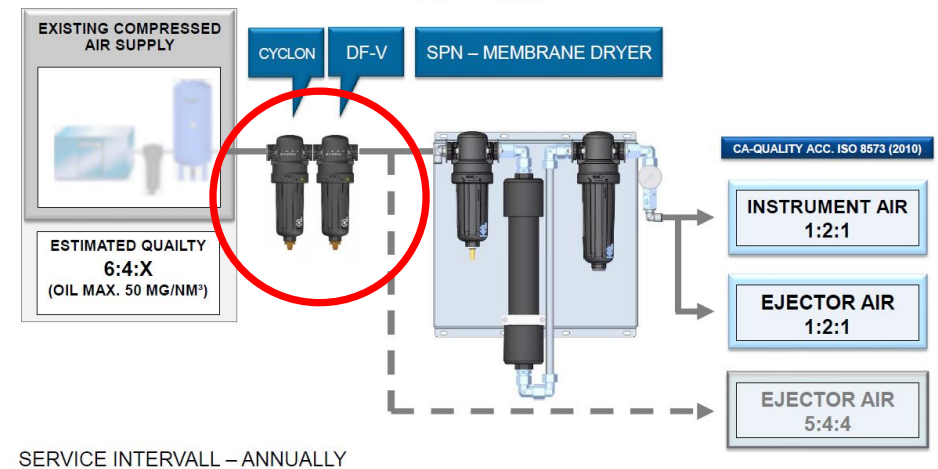



# Too high ambient temperature

**High ambient temperatures** (beyond specifications):

Leads to:

- › Defective electronics
- › Expensive repairs
  
- › Workaround solutions by customers - causing further problems
  - e.g. open cabinet, device exposed to unfiltered environment

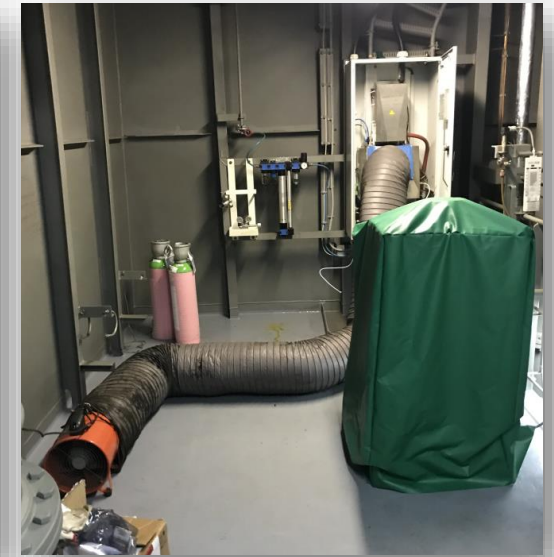
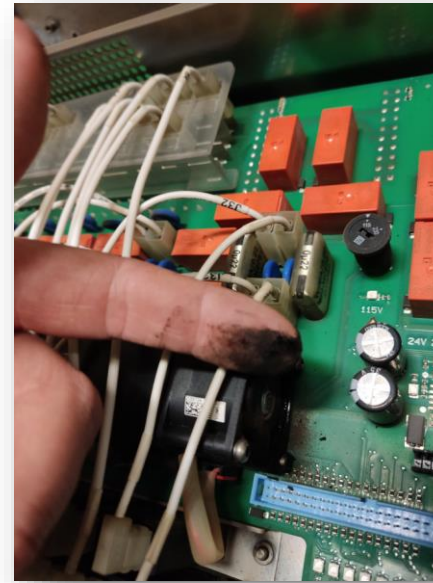

# Too high ambient temperature

## Solution:

### Retrofit of air cooling unit for ambient temp. up to +55°C

- › Fits in size and dimension
- › Device cabinet remains closed
- › Package includes mounting material to reinforce the cabinet
  - Improved vibration resistance
  - Stabilizing elements considered in the design of cooler unit
- › DNV compliant solution
- › AC unit also available as option for new devices



# Improper use of gas sampling unit

## Improper use / Lack of maintenance

Leads to:

- › Loose fit / damaged filters
  - Leakages
  - Wrong measuring results
- › Contamination inside the device
- › Break down of device
  - Costly repairs



# Improper use of gas sampling unit

## Solution:

### Improved handlebar kit for sample gas and filter unit

- › Avoid improper use
  - Due to lack of knowledge by alternating crews
- › Long lasting design to avoid mechanical damage

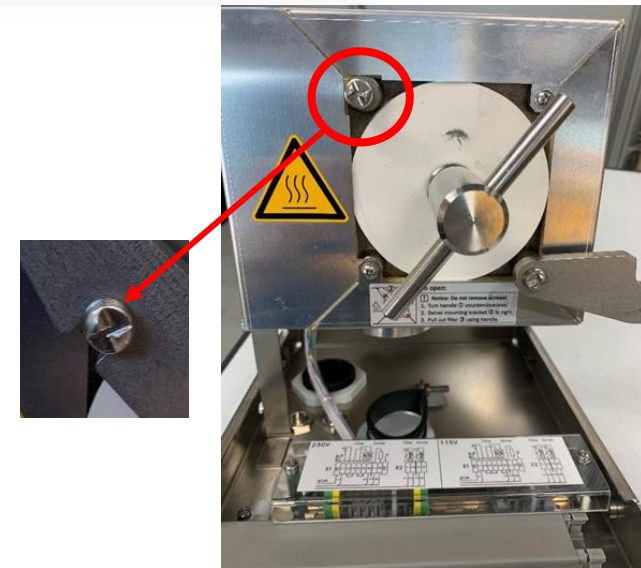

# Maritime Services

## Training - Basic

### Solution

### Maintenance videos

- › Video tutorial for basic maintenance
- › Available 24/7 on youtube
- › Open to public (no registration required)
  
- › QR code for direct access on device and sample gas unit

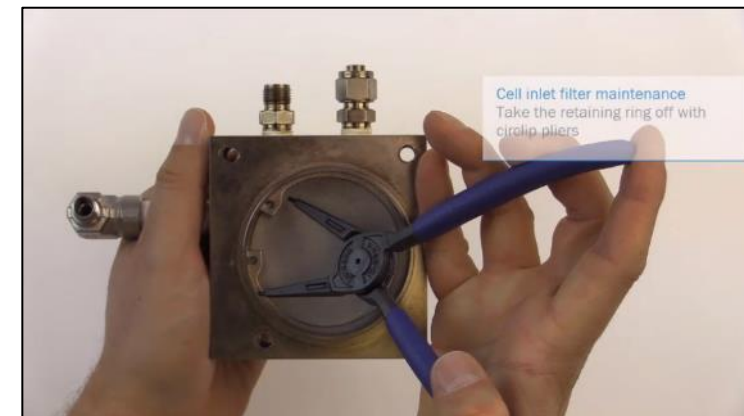
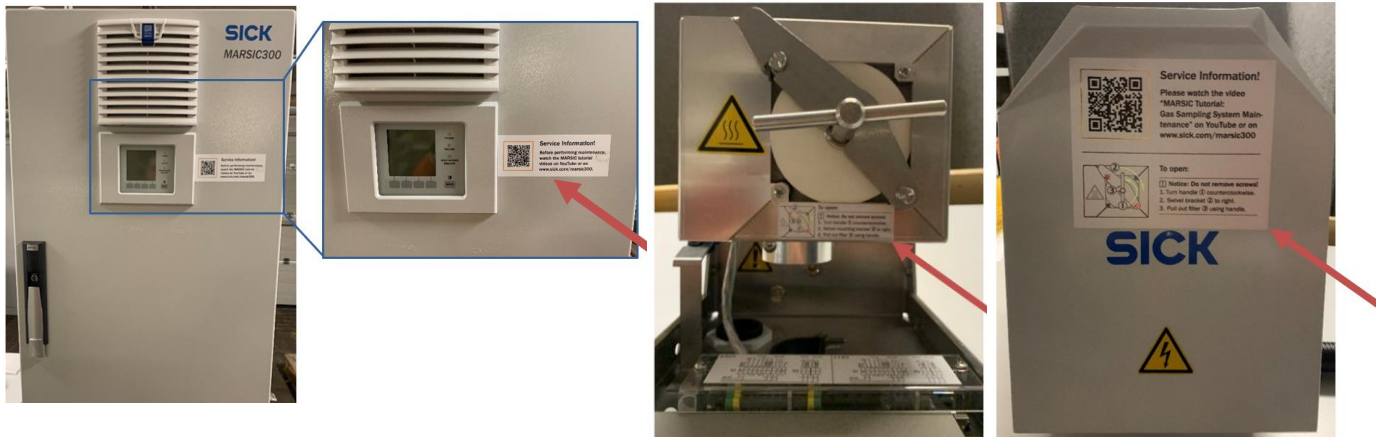
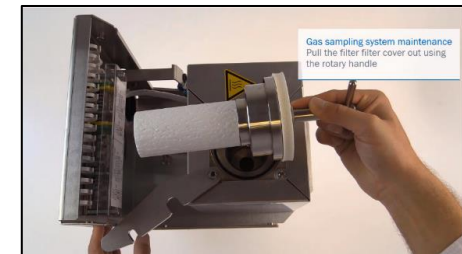
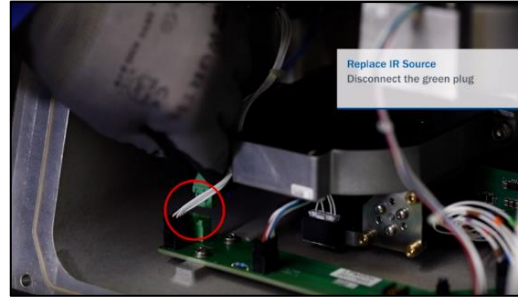

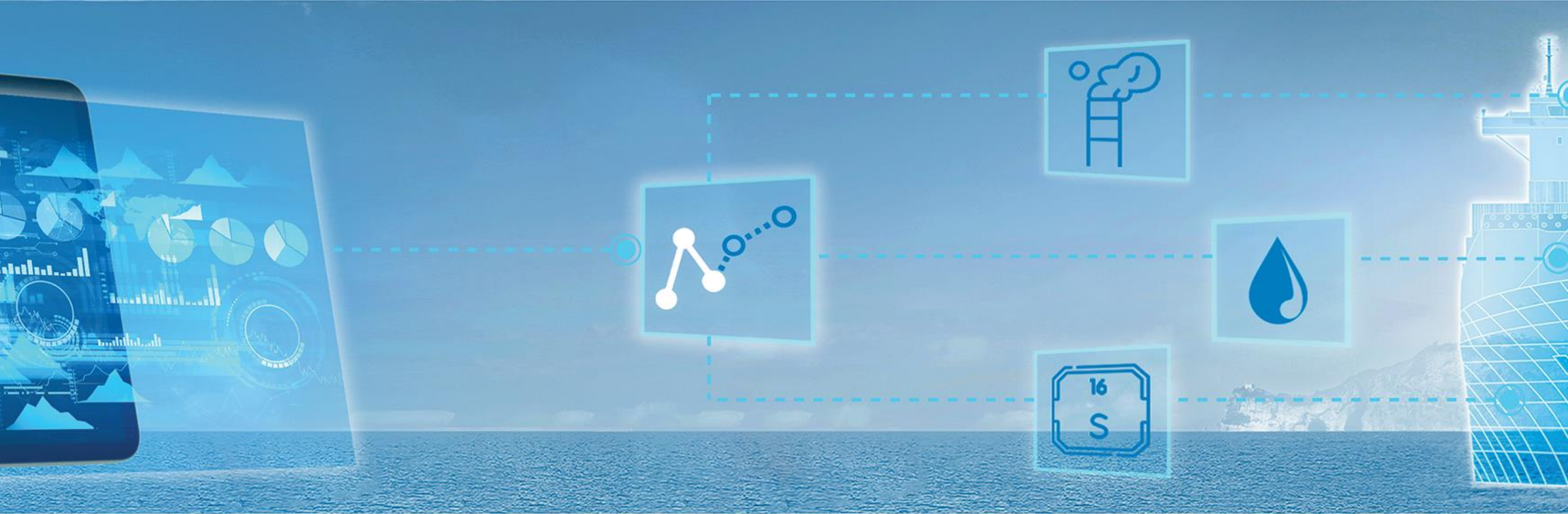

# How to use digital services to support vessels remaining compliant

# SICK Maritime Suite

## Benefit from digitalization:

Software solutions as part of comprehensive approach to improve availability and remaining compliance



Already shown in previous webinar – recordings are available:

→ <https://s.sick.com/fi-en-MARITIME>



## Solutions:

### MARdiagnostics

Condition monitoring solution to visualize device data

Leads to:

- › Transparency
  - Early detection by experts
  - Trend evaluation / prediction
  - Better preparation
- › Data available onshore

### MARpems

Back-up solution by PEMS to remain compliant

Digital twin to back-up the analyzer in single sensor failures

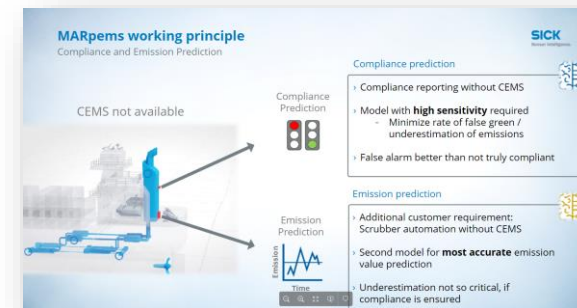



## Global service structure



# Service structure

Gold & Silver ports

SICK Maritime hubs on **main shipping routes** equipped with:

- › Trained Service Engineers
- › Consumables and Spares
- › Access to Modules and Gases
- › Special tools
  
- › Optimized „first time fix rate“



**Other ports on request**



## Summary

# Summary

How to increase the availability of your maritime emission monitoring systems

## SICK can offer you...

- › Upgrade kits for the current system
  - Safety for air quality
  - Safety for high ambient temperature peaks
  - Simplified structure for sample probe filter
- › Free maintenance videos 24/7
- › Digital Services
- › Global Service Structure

## Customer benefits are...

- › Less downtime & higher reliability – confirmed by customers!
- › Less ad-hoc services lead to cost savings
- › Compliant system to avoid penalties

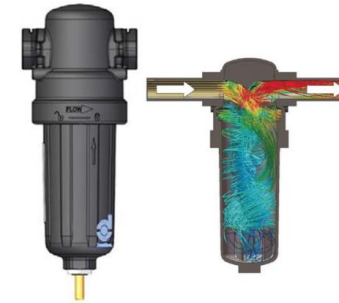



# Thank you for your attention!

**Kangas Heikki**  
Head of Sales & Lead Account Manager,  
Process Automation SICK Oy



Mobile: +358 40 9008033

E-Mail: [heikki.kangas@sick.fi](mailto:heikki.kangas@sick.fi)



**Christian Lohner**  
Product Manager Maritime



Telephone: +49 7551 8429-115  
Mobile: +49 173 6541215

E-Mail: [christian.lohner@sick.de](mailto:christian.lohner@sick.de)



**Felix Baha**  
Product Manager Service



Telephone: +49 7641 469-1405  
Mobile: +49 170 1939712

E-Mail: [felix.baha@sick.de](mailto:felix.baha@sick.de)

